

Evaluation of the Effect of End Conditions on the Load Carrying Capacity of Long Column

Md. Ferdous Wahid^{1*}, Rayhana Sultana², Mijanur Rahman³, Md. Abdul Alim¹, Md. Lutfur Rohman¹

¹Department of Civil Engineering, Sonargaon University, Dhaka, Bangladesh

²Department of Civil Engineering, European University of Bangladesh, Dhaka, Bangladesh

³Rural Power Company Ltd.

*email: mdfwahid@gmail.com

Abstract

The principle aim of the study was to determine the effect of end conditions on the load carrying capacity of slender column. The secondary objective of the research was to compare the theoretical and actual critical stress of the slender column. To achieve the goal of the study, total 64 numbers of slender column of different materials and different cross sections were prepared for the test. The cross-sectional dimensions of square bars considered for the tests were 6mmX6mm, 5mmX5mm, 4mmX4mm and for circular bar the diameters were 6mm, 5mm and 4mm. The length of the columns were 1m and 0.8 m. The support conditions considered for the tests were both end fixed, one end fixed and other one is hinged, both ends hinged and one end fixed other is free. The experimental results show that the actual load carrying capacity of the slender columns were greater most of the time than the theoretical load carrying capacity. Results also show that the load carrying capacity of the column linearly increases with the cross-sectional area for the same column length and end condition. The critical load carrying capacity of both end fixed support condition found significantly higher than the cantilever support condition for the same slender column. The difference between the actual and theoretical load carrying capacity of the slender column inversely varies with the cross-sectional area of the column. Critical load carrying capacity of the slender column made of mild steel specimen was found two times or greater than the stainless-steel specimen and the load carrying capacity of the column linearly increases with the cross-sectional area for the same column length and end condition.

Keywords: Critical Load, Euler Column, Support Conditions, Effective Length, Theoretical Load.

1.0 INTRODUCTION

To fulfill the demand of modern world or to make solutions for population density problems and lack of available land for development, engineers are always on the pressure to construct the enormous number of tall buildings in various parts of the world [1]. The columns supporting those huge structures are subjected to massive loading over it. Some columns not only show lateral displacements but also are fixed at the foot while a load would be applied on the free end. Several possible modes of failure should consider by engineers while designing those structures containing long column [2]. Structure when subjected to any axial loads, any column would deform and may buckle under the variety of loading conditions. When the member suddenly deflects laterally under axial compression, the bearing load is defined as the critical load in the compression member. At some value of the compressive axial load, the member no longer remains straight, but suddenly deflects laterally, bending like a beam. This lateral deflection caused by axial compression is called buckling [3]. The initiation of instability in the loaded structure is known as critical buckling.

Stability denotes one of the main problems in solid mechanics, and to ensure the safety of structures against collapse it must be controlled. An elastic column is said to be stable in classical stability analysis, if for any randomly small displacement from its equilibrium position the column either returns to its original uninterrupted position or acquires an adjoined stable position when left to itself [4]. In most of the real world engineering applications, stability analysis of the compressed members is very important. There have been lots of researches related to the buckling behavior of the axially compressed members [5] [6]. One of the fundamental forms of the instability of column structures is buckling. Buckling is a phenomenon that occurs in structures, which are stiff in the loaded direction and slender in another direction. The load at which buckling happens depends on the stiffness of a component, not upon the strength of its materials. The loss of stability of a component is referred to as buckling and is usually independent of material strength. This loss of stability usually occurs within the elastic range of the material [7]. Initially, equilibrium is stable but when the load is increased there is a sudden increase in deflection in loading direction due to a displacement in the slender direction [8]. The critical buckling load by closed mathematical formulae in case of simple beams with

several support conditions at their ends was first determined by Euler in 1744 [9][10]. The solutions for the elastic buckling analysis of columns under various loading, restraint and boundary conditions are well documented in the literature. Unlike beams subjected to transverse loads and small axial forces, columns are quite sensitive to imperfections [11]. Imperfections have been recognized for a long time and their effects on structural stability have been well investigated. For long columns, overall (Euler) buckling is more likely to occur before any other instability failure. For short columns, local buckling occurs first, leading either to large deflections and finally overall buckling, or to material degradation due to large deflections (cripling). The local buckling critical load determined using a plate analysis [12].

1.1 Euler Theory for Buckling of Columns

1.1.1 Buckling

Buckling is an instability phenomenon that causes failure on a structure and is accompanied by large deflections and non-linear behavior. Buckling failure has been observed in long columns under axial loading where failure occurs for axial stress much lower than the yield stress of the material. Euler, based upon this fact, concluded that this instability was due to the geometry of the column (i.e. length l and bending stiffness EI) and he solved the problem mathematically. Many researchers followed the same procedure in order to solve more specific cases, where the boundary conditions or eccentricities in application of the load are important [13]. Buckling failures are often sudden and catastrophic, and engineers are ought to know how they can be prevented. Whenever the columns are applied to a load, there are three modes of failure, either crushing or buckling or both. Generally, short columns fail due to crushing and long columns due to buckling. The intermediates would usually fail due to both. Hence, we classify the columns into short and long columns based on the parameter called as slenderness ratio. It is defined as the ratio of effective length to the minimum radius of gyration. The effective length is defined as the length of the columns between the lateral supports. The radius of gyration is the root of the ratio of Moment of Inertia to the cross-sectional area

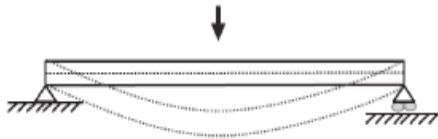

Fig. 1: Bending deformation[14]

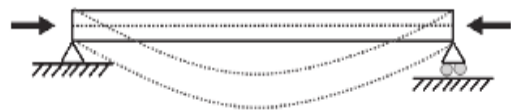

Fig. 2: Buckling deformation[14]

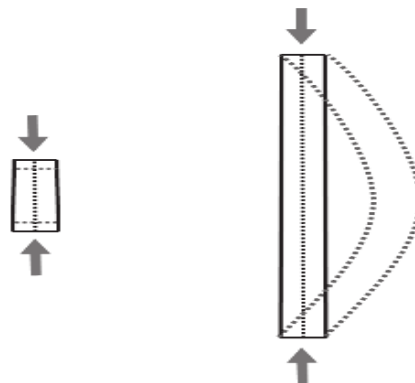

Fig. 3: Crushing deformation and buckling deformation [14]

1.1.2 Assumptions that are considered for the Euler Theory

The following assumptions are made for the analysis.

- i. The column is perfectly straight and the load is applied axially.
- ii. The cross-section of the column is uniform. The column is perfectly elastic, homogeneous and isotropic material.
- iii. The length of the column is very large compared to the cross-section.
- iv. The shortening of the column due to direct compression is neglected.
- v. The column fails by buckling only.

The maximum load that a column could withstand without any lateral displacement is called buckling load or Euler buckling load or critical load.

1.1.3 Euler's critical load

The Euler's critical load formula can be used to determine the maximum axial force that a column can withstand before it fails due to flexural buckling: [15]

$$P_{cr} = \frac{\pi^2 EI}{(kL)^2} \quad (1)$$

$$\sigma_{cr} = \frac{\pi^2 EI}{(kL/r)^2} \quad (2)$$

- P_{cr} = Critical Force or Maximum force or buckling load or Euler buckling load or critical load
- σ_{cr} = Critical Stress
- E = Modulus Of Elasticity
- I = Area Moment Of Inertia
- K = Effective Length Factor
- L = Length Of Column
- r = Slenderness Ratio.

This equation is also known as Euler's buckling formula. From this equation, it is easy to see that the maximum force will increase when the length of the column decreases and vice versa. By, for example, doubling the length of a given column, it can now only carry one quarter of the original maximum force. The choice of support (pinned/fixed) is also a very important factor as it directly affects the effective length of the column. The theoretical factor is based on the deformation shape the column will develop during buckling. Standards often use a recommended design value for the effective length factor, which for some supports is more conservative [14].

1.1.4 End support conditions

Previously, each column was assumed to have pinned ends in which the member ends were free to rotate (but not translate) in any direction at their ends.[16]

- When the column buckles, it will do so in one smooth curve.
- The length of this curve is referred to as the effective length.

In practice, a column may not be pinned at the ends.

- The column length free to buckle is greatly influenced by its end support conditions.
 - The load-carrying capacity of a column is affected by the end support conditions.
- Restraining the ends of a column with a fixed support increases the load-carrying capacity of a column.
 - Allowing translation as well as rotation (i.e. free end) at one end of a column generally reduces its load-carrying capacity.

Column design formulas generally assume a condition in which both ends are pinned. When other conditions exist, the load-carrying capacity is increased or decreased and the allowable compressive stress is increased or decreased. A factor K is used as a multiplier for converting the actual column length to an effective buckling length based on end conditions. The American Institute of Steel Construction (AISC) provides recommended effective length factors when ideal conditions are approximated. The six cases are presented as follows.

Case A: Both ends are pinned

The structure is adequately braced against lateral forces (e.g. wind and earthquake forces).

Theoretical K-value: $K = 1.0$

Effective length: $L_e = K_L = L$

$$P_{cr} = \frac{\pi^2 EI}{(L)^2} \quad (3a)$$

Case B: Both ends are fixed

The structure is adequately braced against lateral forces (e.g. wind and earthquake forces).

Theoretical K-value: $K = 0.5$

Effective length: $L_e = K_L = 0.5 L$

$$P_{cr} = \frac{4\pi^2 EI}{(L)^2} \tag{3b}$$

Case C: One end is pinned and one end is fixed

The structure is adequately braced against lateral forces (e.g. wind and earthquake forces).

Theoretical K-value: $K = \sqrt{2}$

Effective length: $L_e = \sqrt{2}L$

$$P_{cr} = \frac{2\pi^2 EI}{(L)^2} \tag{3c}$$

Case D: One end is free and one end is fixed

Lateral translation is possible and an eccentric column load is developed.

Theoretical K-value: $K = 2.0$

Effective length: $L_e = 2.0 L$

$$P_{cr} = \frac{\pi^2 EI}{4(L)^2} \tag{3d}$$

Case E: Both ends are fixed with some lateral translation

Theoretical K-value: $K = 1.0$

Effective length: $L_e = 1.0 L$

$$P_{cr} = \frac{\pi^2 EI}{(L)^2} \tag{3e}$$

Case F: The base is pinned and the top is fixed with some lateral translation

Theoretical K-value: $K = 2.0$

Effective length: $L_e = 2.0 L$

$$P_{cr} = \frac{\pi^2 EI}{4(L)^2} \tag{3f}$$

2.0 RESULTS

Total 40 numbers of spiral column and 24 numbers of rectangular or square column of different dimensions were tested for the study. The length of the columns were 1m and 0.8m. Cross sectional dimensions of the square columns were 6 mm × 6mm, 5mm × 5mm and 4mm × 4mm. The diameter of the spiral columns considered for the test were 6mm, 5mm and 4mm. Four different support conditions were considered for the study with Mild steel and stainless steel specimens. The support conditions considered for the study were Both end hinged, One end fixed and other is hinged, Both end fixed, One end fixed and other is free or cantilever.

2.1 Experimental Results of Spiral Columns

2.1.1 Experimental results of spiral columns made with mild steel specimens

All the results of 1 m length spiral column made with mild steel specimens are presented in Tables (1-3) and the corresponding graphical presentation of the data are shown in Figures (4-9).

Table 1: Actual and theoretical stress of 6 mm dia. 1 m length spiral column made with Mild steel specimens

End condition	Dia. of the column (mm)	Cross sectional area (A) (mm ²)	Radius of gyration (r)	Length of the column (L) (mm)	Eff. Length (Le) (mm)	Le/r (mm)	Critical load (P) (N)	Actual Critical stress (P/A) (MPa)	Theo. Critical stress (MPa)
Both end fixed	6	28.274	1.5	1000	500	333.33	990.81	35.043	17.765
One end hinged and other is fixed	6	28.274	1.5	1000	707	471.33	494.486	17.489	8.885
Both end hinged	6	28.274	1.5	1000	1000	666.67	192.276	6.800	4.441
Cantilever	6	28.274	1.5	1000	2000	1333.33	54.936	1.943	1.110

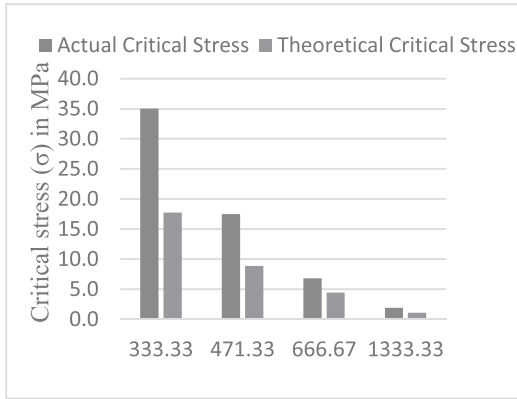

Fig. 4: $\frac{L_e}{r}$ Vs Critical Stress in MPa

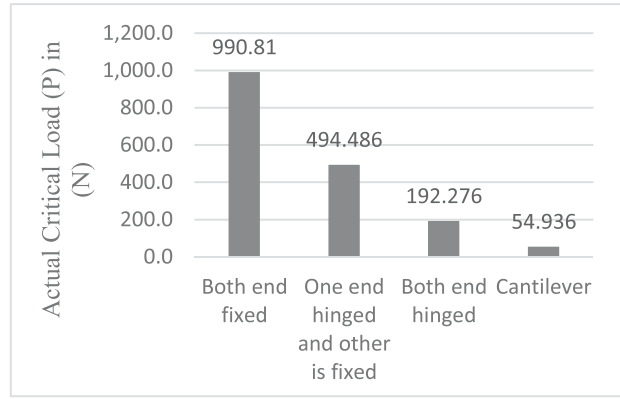

Fig. 5: Support Conditions Vs Critical Load (P) in (N)

Diameter of the columns considered for the study were 6 mm, 5mm and 4mm. Experimental results show that the load carrying capacity of spiral column decreases with the increase in the ratio of the effective length to radius of gyration. Load carrying capacity of column with both end fixed condition found significantly higher than the column having cantilever end condition. Actual critical stresses obtained from the tests were always found higher than the critical stresses obtained theoretically.

Table 2: Actual and theoretical stress of 5 mm dia. 1 m length spiral column with Mild steel specimens

End condition	Dia. of the column (mm)	Cross sectional area (A) (mm ²)	Radius of gyration (r)	Length of the column (L) (mm)	Eff. Length (L _e) (mm)	Le/r (mm)	Critical load (P) (N)	Actual Critical stress (P/A) (MPa)	Theo. Critical stress (MPa)
Both end fixed	5	19.635	1.25	1000	500	400	496.386	25.281	12.337
One end hinged and other is fixed	5	19.635	1.25	1000	707	565.6	349.236	17.786	6.170
Both end hinged	5	19.635	1.25	1000	1000	800	123.606	6.295	3.084
Cantilever	5	19.635	1.25	1000	2000	1600	34.335	1.749	0.771

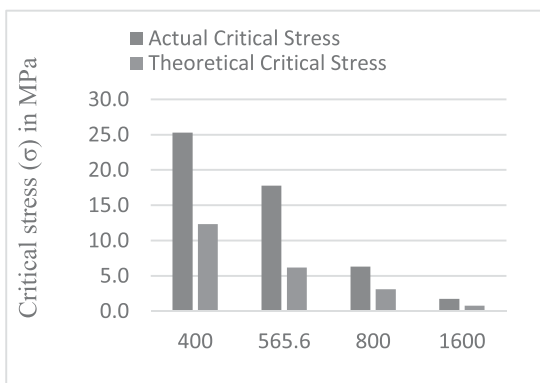

Fig. 6: $\frac{L_e}{r}$ Vs Critical Stress in MPa.

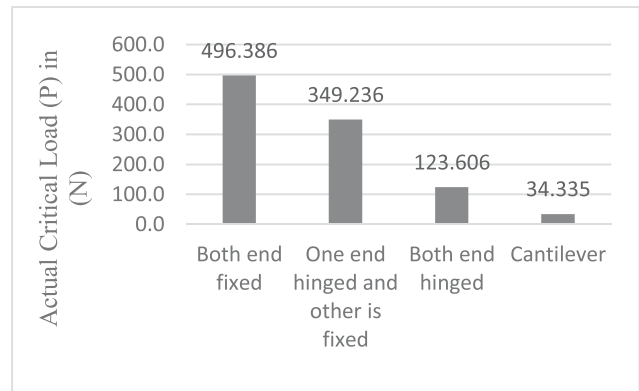

Fig. 7: Support Conditions Vs Critical Load (P) in (N)

Table 3: Actual and theoretical stress of 4 mm dia. 1 m length spiral column with Mild steel specimens.

End condition	Dia. of the column (mm)	Cross sectional area (A) (mm ²)	Radius of gyration (r)	Length of the column (L) (mm)	Eff. Length (L _e) (mm)	Le/r (mm)	Critical load (P) (N)	Actual Critical stress (P/A) (MPa)	Theo. Critical stress (MPa)
Both end fixed	4	12.566	1.0	1000	500	500	300.19	23.888	7.896
One end hinged and other is fixed	4	12.566	1.0	1000	707	707	143.23	11.398	3.949
Both end hinged	4	12.566	1.0	1000	1000	1000	74.56	5.933	1.974
Cantilever	4	12.566	1.0	1000	2000	2000	19.62	1.561	0.493

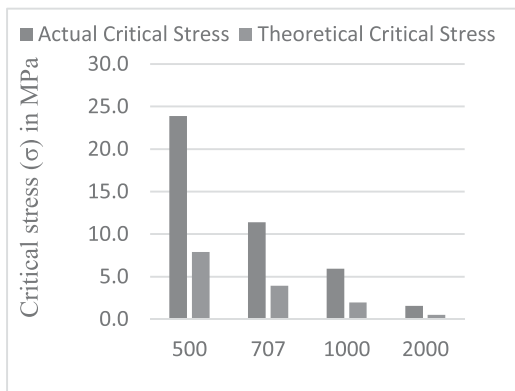

Fig. 8: $\frac{L_e}{r}$ Vs Critical Stress in MPa.

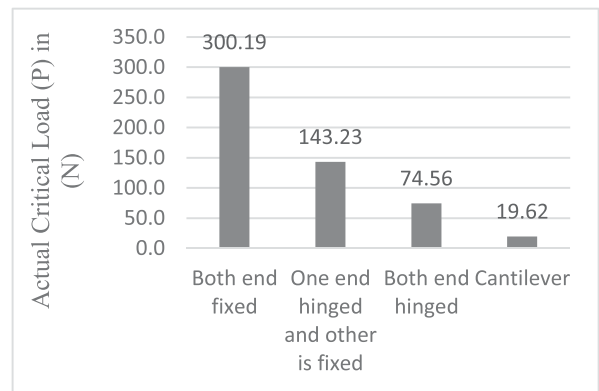

Fig. 9: Support Conditions Vs Critical Load (P) in (N)

All the results of 0.8 m length spiral column made with mild steel specimens are presented in Tables 4-6. and corresponding graphical presentation of the data are shown in Figures 10-15. Diameter of the columns were same as for 1m length spiral columns. Experimental results show that the load carrying capacity of spiral column also decreases with the increase in the ratio of the effective length to radius of gyration. Load carrying capacity of column with both end fixed condition found significantly higher than the column having cantilever end condition. Actual critical stresses obtained from the tests also always found higher than the critical stresses obtained theoretically.

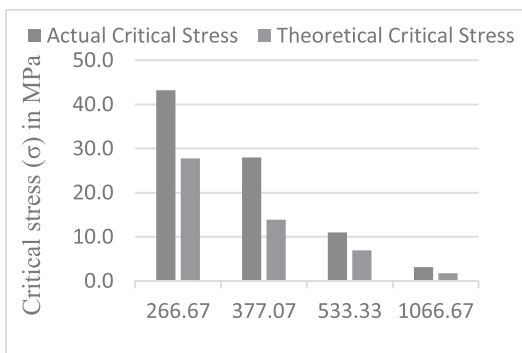

Fig. 10: $\frac{L_e}{r}$ Vs Critical Stress in MPa.

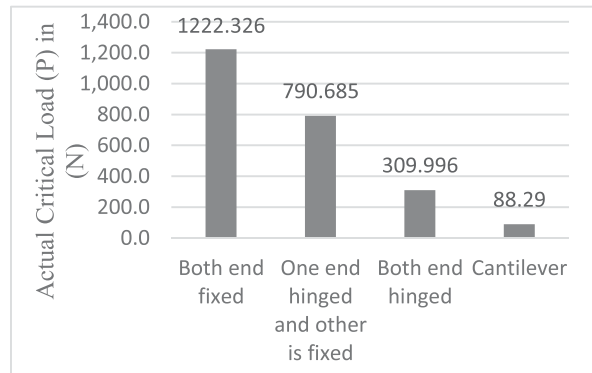

Fig. 11: Support Conditions Vs Critical Load (P) in (N)

Table 4: Actual and theoretical stress of 6 mm dia. 0.8 m length spiral column with mild steel specimens.

End condition	Dia. of the column (mm)	Cross sectional area (A) (mm ²)	Radius of gyration (r)	Length of the column (L) (mm)	Eff. Length (L _e) (mm)	Le/r (mm)	Critical load (P) (N)	Actual Critical stress (P/A) (MPa)	Theo. Critical stress (MPa)
Both end fixed	6	28.2743	1.5	800	400	266.67	1222.33	43.2309	27.758
One end hinged and other is fixed	6	28.2743	1.5	800	565.6	377.07	790.685	27.9648	13.883
Both end hinged	6	28.2743	1.5	800	800	533.33	309.996	10.9639	6.940
Cantilever	6	28.2743	1.5	800	1600	1066.67	88.29	3.12262	1.735

Table 5: Actual and theoretical stress of 5 mm dia. 0.8 m length spiral column with mild steel specimens.

End condition	Dia. of the column (mm)	Cross sectional area (A) (mm ²)	Radius of gyration (r)	Length of the column (L) (mm)	Eff. Length (L _e) (mm)	Le/r (mm)	Critical load (P) (N)	Actual Critical stress (P/A) (MPa)	Theo. Critical stress (MPa)
Both end fixed	5	19.63495	1.25	800	400	320	731.886	37.2746	19.277
One end hinged and other is fixed	5	19.63495	1.25	800	565.6	452.48	535.626	27.2792	9.641
Both end hinged	5	19.63495	1.25	800	800	640	202.086	10.2922	4.819
Cantilever	5	19.63495	1.25	800	1600	1280	49.05	2.4981	1.205

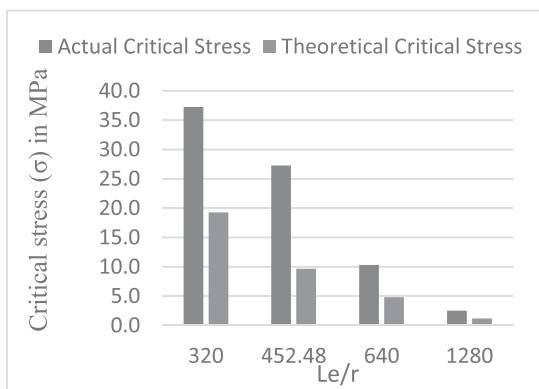

Fig. 12: $\frac{L_e}{r}$ Vs Critical Stress in MPa.

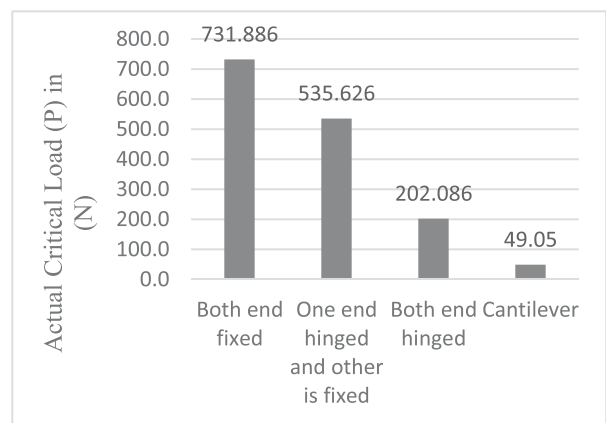

Fig. 13: Support Conditions Vs Critical Load (P) in (N)

Table 6: Actual and theoretical stress of 4 mm dia. 0.8 m length spiral column with mild steel specimens.

End condition	Dia. of the column (mm)	Cross sectional area (A) (mm ²)	Radius of gyration (r)	Length of the column (L) (mm)	Eff. Length (Le) (mm)	Le/r (mm)	Critical load (P) (N)	Actual Critical stress (P/A) (MPa)	Theo. Critical stress (MPa)
Both end fixed	4	12.56637	1	800	400	400	437.526	34.8172	12.337
One end hinged and other is fixed	4	12.56637	1	800	565.6	565.6	300.186	23.888	6.170
Both end hinged	4	12.56637	1	800	800	800	113.796	9.0556	3.084
Cantilever	4	12.56637	1	800	1600	1600	29.43	2.34196	0.771

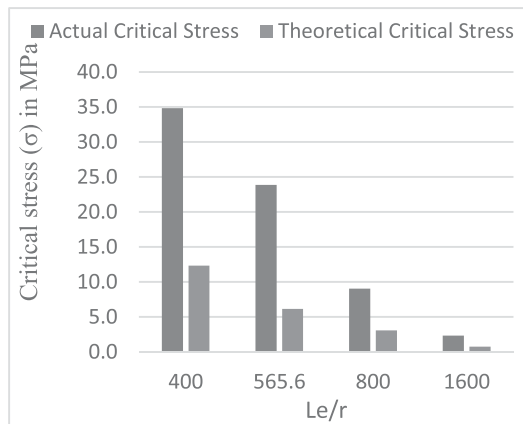

Fig. 14: $\frac{L_e}{r}$ Vs Critical Stress in MPa.

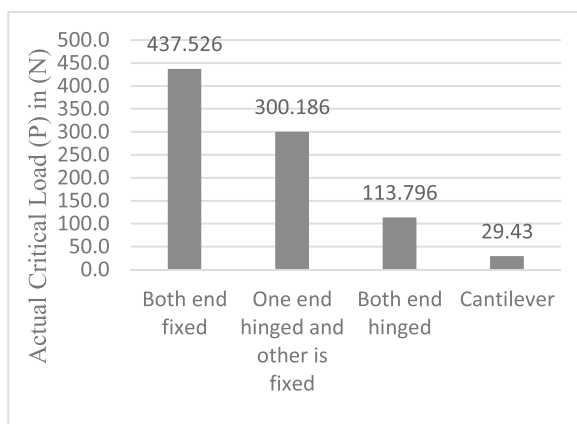

Fig. 15: Support Conditions Vs Critical Load (P) in (N)

2.1.2 Experimental results of spiral columns with stainless steel specimens

Experimental results of 1 m length spiral column made with stainless steel specimens are presented in **Tables 7-8**. The corresponding graphical representation of the data are shown in **Figures 16-19**. Diameter of the columns were 5mm and 4mm.

Table 7: Actual and theoretical stress of 5 mm dia. 1m length spiral column with stainless steel specimens.

End condition	Dia. of the column (mm)	Cross sectional area (A) (mm ²)	Radius of gyration (r)	Length of the column (L) (mm)	Eff. Length (Le) (mm)	Le/r (mm)	Critical load (P) (N)	Actual Critical stress (P/A) (MPa)	Theo. Critical stress (MPa)
Both end fixed	5	19.635	1.25	1000	500	400	241.33	12.291	12.337
One end hinged and other is fixed	5	19.635	1.25	1000	707	565.6	113.80	5.796	6.170
Both end hinged	5	19.635	1.25	1000	1000	800	54.94	2.798	3.084
Cantilever	5	19.635	1.25	1000	2000	1600	19.62	0.999	0.771

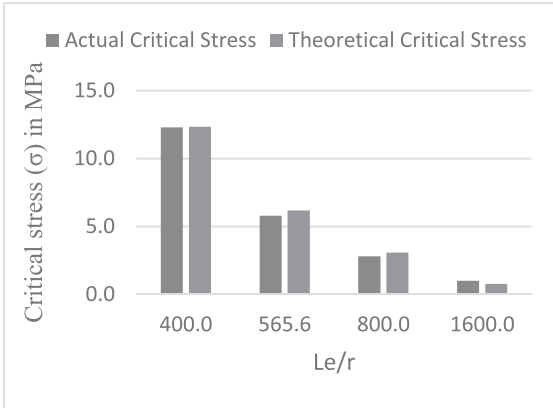

Fig. 16: $\frac{L_e}{r}$ Vs Critical Stress in MPa.

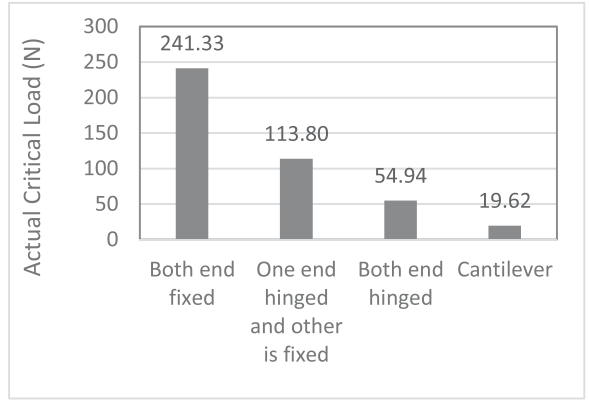

Fig. 17: Support Conditions Vs Critical Load (P) in (N)

Table 8: Actual and theoretical stress of 4 mm dia. 1m length spiral column with stainless steel specimens.

End condition	Dia. of the column (mm)	Cross sectional area (A) (mm ²)	Radius of gyration (r)	Length of the column (L) (mm)	Eff. Length (Le) (mm)	Le/r (mm)	Critical load (P) (N)	Actual Critical stress (P/A) (MPa)	Theo. Critical stress (MPa)
Both end fixed	4	12.566	1	1000	500	500	84.366	6.714	7.896
One end hinged and other is fixed	4	12.566	1	1000	707	707	54.936	4.372	3.949
Both end hinged	4	12.566	1	1000	1000	1000	45.126	3.591	1.974
Cantilever	4	12.566	1	1000	2000	2000	7.3575	0.585	0.493

Experimental results show that the load carrying capacity of spiral column decreases with the increase in the ratio of the effective length to radius of gyration. Load carrying capacity of column with both end fixed condition found significantly higher than the column having cantilever end condition. Actual critical stresses obtained from the tests were always found higher than the critical stresses obtained theoretically except the column with both end fixed condition.

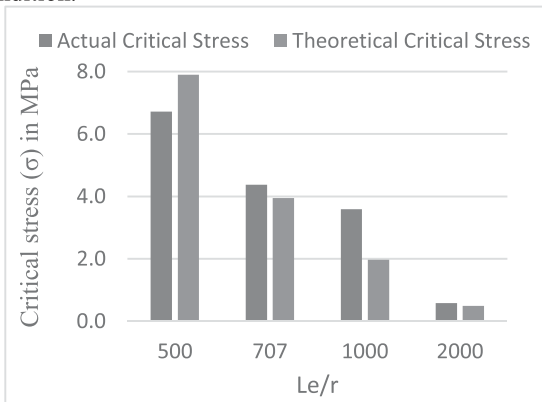

Fig. 18: $\frac{L_e}{r}$ Vs Critical Stress in MPa.

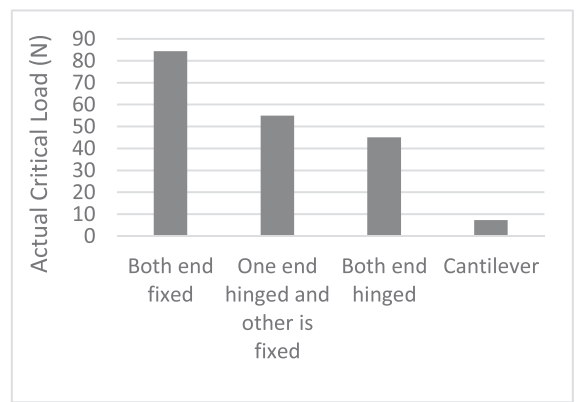

Fig. 19: Support Conditions Vs Critical Load (P) in (N)

All the results of 0.8 m length spiral column made with stainless steel specimens are presented in **Table 9-10** and corresponding graphical representation of the data are shown in **Fig. 20-23**.

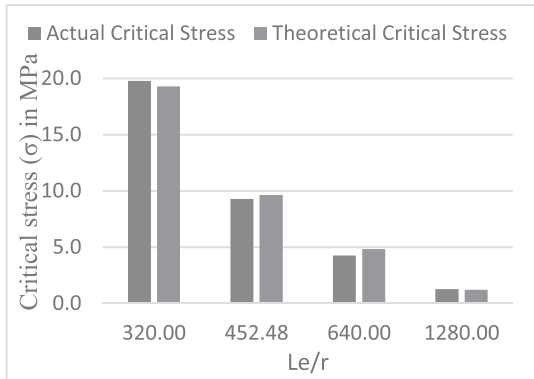

Fig. 20: $\frac{L_e}{r}$ Vs Critical Stress in MPa.

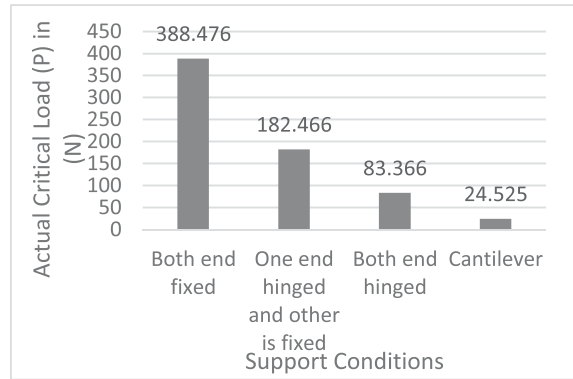

Fig. 21: Support Conditions Vs Critical Load (P) in (N)

Table 9: Actual and theoretical stress of 5 mm dia. 0.8 m length spiral column with stainless steel specimens.

End condition	Dia. of the column (mm)	Cross sectional area (A) (mm ²)	Radius of gyration (r)	Length of the column (L) (mm)	Eff. Length (Le) (mm)	Le/r (mm)	Critical load (P) (N)	Actual Critical stress (P/A) (MPa)	Theo. Critical stress (MPa)
Both end fixed	5	19.635	1.25	800	400	320.00	388.476	19.785	19.277
One end hinged and other is fixed	5	19.635	1.25	800	565.6	452.48	182.466	9.293	9.641
Both end hinged	5	19.635	1.25	800	800	640.00	83.366	4.246	4.819
Cantilever	5	19.635	1.25	800	1600	1280.00	24.525	1.249	1.205

Table 10: Actual and theoretical stress of 4 mm dia. 0.8 m length spiral column with stainless steel specimens.

End condition	Dia. of the column (mm)	Cross sectional area (A) (mm ²)	Radius of gyration (r)	Length of the column (L) (mm)	Eff. Length (Le) (mm)	Le/r (mm)	Critical load (P) (N)	Actual Critical stress (P/A) (MPa)	Theo. Critical stress (MPa)
Both end fixed	4	12.566	1	800	400	400	143.226	11.398	12.337
One end hinged and other is fixed	4	12.566	1	800	565.6	565.6	94.176	7.494	6.170
Both end hinged	4	12.566	1	800	800	800	45.126	3.591	3.084
Cantilever	4	12.566	1	800	1600	1600	8.3385	0.664	0.771

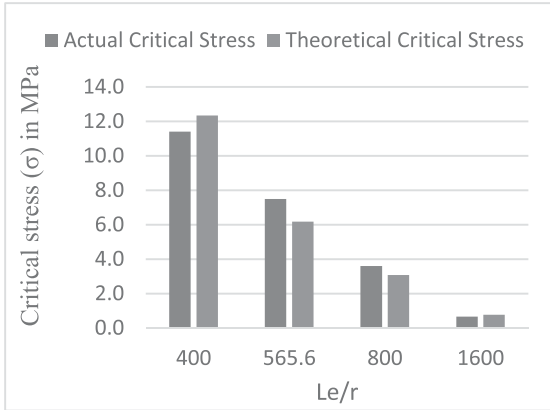

Fig. 22: $\frac{L_e}{r}$ Vs Critical Stress in MPa.

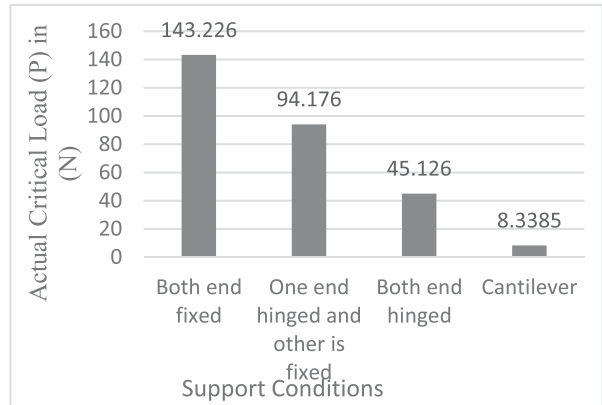

Fig. 23: Support Conditions Vs Critical Load (P) in (N)

Diameter of the columns were 5mm and 4mm. Experimental results show that the load carrying capacity of spiral column also decreases with the increase in the ratio of the effective length to radius of gyration. Load carrying capacity of column with both end fixed condition found significantly higher than the column having cantilever end condition. Actual critical stresses obtained from the tests also always found higher than the critical stresses obtained theoretically.

2.1 Experimental results of tide columns

2.1.1 Experimental results of tide columns made with mild steel specimens

All the results of 1 m length tide column made with mild steel specimens are presented in **Table 11-13** and the corresponding graphical representation of the data are shown in **Figures 24-29**. Cross sectional dimensions of the columns were 6mm X 6mm, 5mm X 5mm and 4mm X 4mm. Experimental results show that the load carrying capacity of spiral column decreases with the increase in the ratio of the effective length to radius of gyration. Load carrying capacity of column with both end fixed condition found significantly higher than the column having cantilever end condition. Actual critical stresses obtained from the tests were always found higher than the critical stresses obtained theoretically.

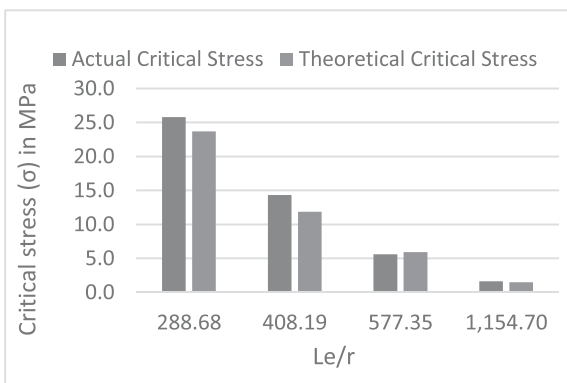

Fig. 24: $\frac{L_e}{r}$ Vs Critical Stress in MPa.

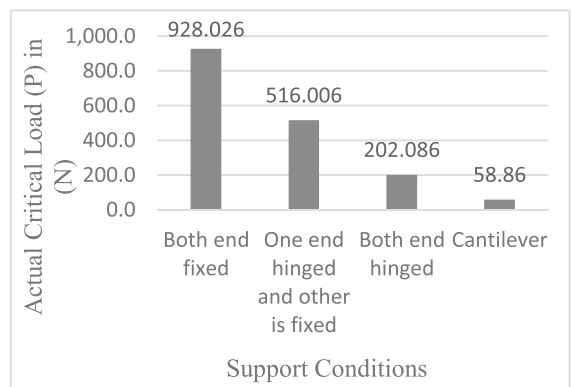

Fig. 25: Support Conditions Vs Critical Load (P) in (N)

Table 11: Actual and theoretical stress of 6 mm X 6 mm and 1.0 m length square column made with mild steel specimens.

End condition	Cross sectional size of the column in (mm)		Cross sectional area (A) in (mm ²)	Radius of gyration (r)	Length of the column (L) in (mm)	Eff. Length (Le) in (mm)	Le/r in (mm)	Critical load in (N) (P)	Actual Critical stress in MPa P/A	Theo. Critical stress in MPa
	Width	Thickness								
Both end fixed	6	6	36	1.7320	1000	500	288.675	928.026	25.7785	23.687
One end hinged and other is fixed	6	6	36	1.7320	1000	707	408.187	516.006	14.3335	11.847
Both end hinged	6	6	36	1.7320	1000	1000	577.35	202.086	5.6135	5.922
Cantilever	6	6	36	1.7320	1000	2000	1154.7	58.86	1.635	1.480

Table 12: Actual and theoretical stress of 5 mm X 5 mm and 1.0 m length square column made with mild steel specimens.

End condition	Cross sectional size of the column in (mm)		X. sectional area (A) in (mm ²)	Radius of gyration (r)	Length of the column (L) in (mm)	Eff. Length (Le) in (mm)	Le/r in (mm)	Critical load in (N) (P)	Actual Critical stress in MPa P/A	Theo. Critical stress in MPa
	Width	Thickness								
Both end fixed	5	5	25	1.44338	1000	500	346.41	476.766	19.0706	16.449
One end hinged and other is fixed	5	5	25	1.44338	1000	707	489.82	251.136	10.0454	8.227
Both end hinged	5	5	25	1.44338	1000	1000	692.82	103.986	4.15944	4.112
Cantilever	5	5	25	1.4434	1000	2000	1385.6	34.335	1.3734	1.028

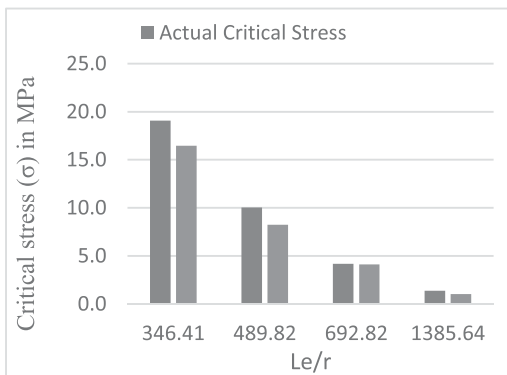

Fig. 26: $\frac{Le}{r}$ Vs Critical Stress in MPa.

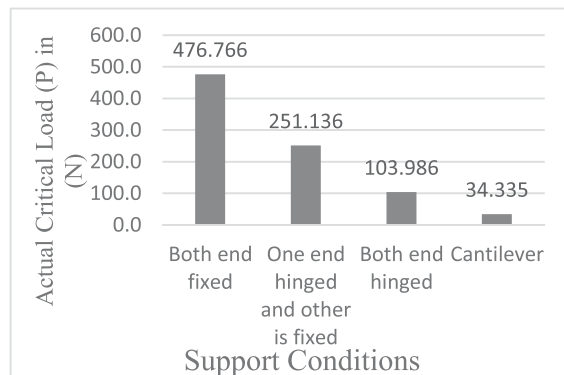

Fig. 27: Support Conditions Vs Critical Load (P) in (N)

Table 13: Actual and theoretical stress of 4 mm X 4 mm and 1.0 m length square column made with mild steel specimens.

End condition	Cross sectional size of the column in (mm)		X. sectional area (A) in (mm ²)	Radius of gyration (r)	Length of the column (L) in (mm)	Eff. Length (Le) in (mm)	Le/r in (mm)	Critical load in (N) (P)	Actual Critical stress in MPa P/A	Theo. critical stress in MPa
	Width	Thickness								
Both end fixed	4	4	16	1.1547	1000	500	433.01	182.466	11.4041	10.528
One end hinged and other is fixed	4	4	16	1.1547	1000	707	612.28	143.226	8.95163	5.265
Both end hinged	4	4	16	1.1547	1000	1000	866.03	45.126	2.82038	2.632
Cantilever	4	4	16	1.1547	1000	2000	1732.1	14.715	0.9197	0.658

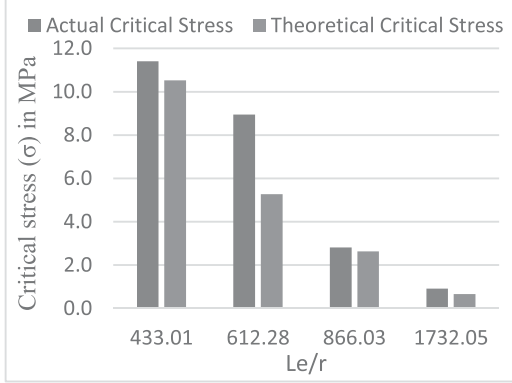

Fig. 28: $\frac{L_e}{r}$ Vs Critical Stress in MPa.

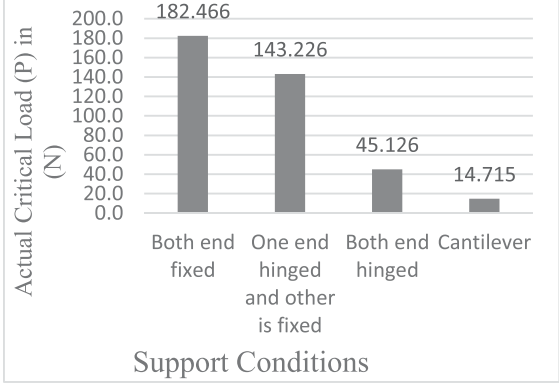

Fig. 29: Support Conditions Vs Critical Load (P) in (N)

Experimental results of 0.8 m length tide column made with stainless steel specimens are presented in **Table 14-16** and the corresponding graphical representation of the data are shown in **Figures 30-35**.

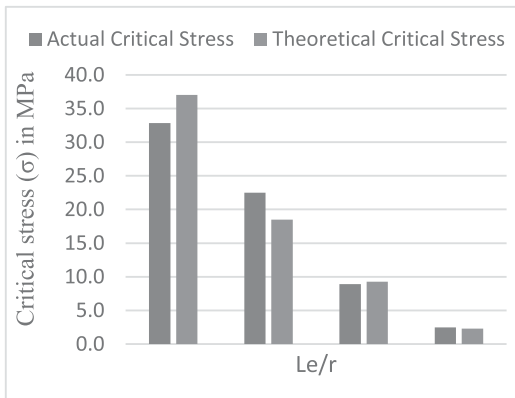

Fig. 30: $\frac{L_e}{r}$ Vs Critical Stress in MPa.

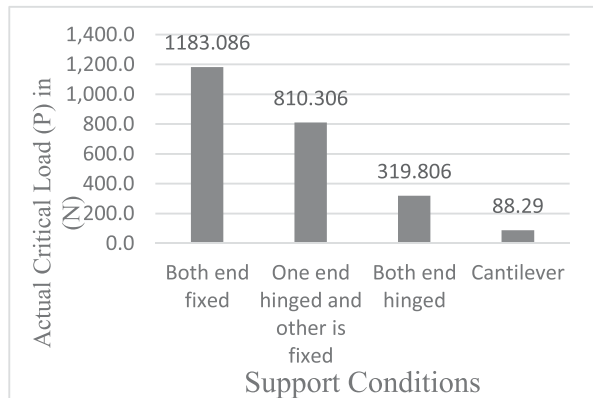

Fig. 31: Support Conditions Vs Critical Load (P) in (N)

Table 14: Actual and theoretical stress of 6 mm X 6 mm and 0.8 m length square column made with mild steel specimens.

End condition	Cross sectional size of the column in (mm)		X. sectional area (A) in (mm ²)	Radius of gyration (r)	Length of the column (L) in (mm)	Eff. Length (Le) in (mm)	Le/r in (mm)	Critical load in (N) (P)	Actual Critical stress in MPa P/A	Theo. critical stress in MPa
	Width	Thickness								
Both end fixed	6	6	36	1.73205	800	400	230.94	1183.09	32.8635	37.011
One end hinged and other is fixed	6	6	36	1.73205	800	565.6	326.549	810.306	22.5085	18.511
Both end hinged	6	6	36	1.73205	800	800	461.88	319.806	8.8835	9.253
Cantilever	6	6	36	1.73205	800	1600	923.76	88.29	2.4525	2.313

Table 15: Actual and theoretical stress of 5 mm X 5 mm and 0.8 m length square column made with mild steel specimens.

End condition	Cross sectional size of the column in (mm)		X. sectional area (A) in (mm ²)	Radius of gyration (r)	Length of the column (L) in (mm)	Eff. Length (Le) in (mm)	Le/r in (mm)	Critical load in (N) (P)	Actual Critical stress in MPa P/A	Theo. critical stress in MPa
	Width	Thickness								
Both end fixed	5	5	25	1.4434	800	400	277.13	633.726	25.349	25.702
One end hinged and other is fixed	5	5	25	1.4434	800	565.6	391.86	417.906	16.7162	12.855
Both end hinged	5	5	25	1.4434	800	800	554.26	162.846	6.51384	6.426
Cantilever	5	5	25	1.4434	800	1600	1108.5	44.145	1.7658	1.606

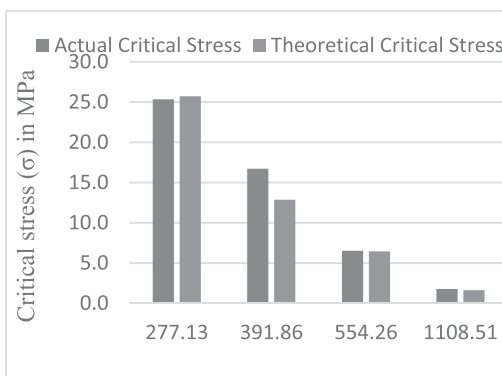

Fig. 32: $\frac{L_e}{r}$ Vs Critical Stress in MPa.

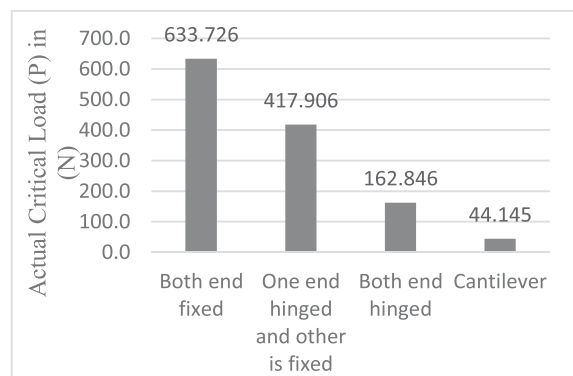

Fig. 33: Support Conditions Vs Critical Load (P) in (N)

Cross sectional dimensions of the columns were 6mm X 6mm, 5mm X 5mm and 4mm X 4mm. Experimental results show that the load carrying capacity of spiral column decreases with the increase in the ratio of the effective length to radius of gyration. Load carrying capacity of column with both end fixed condition found significantly higher than the column having cantilever end condition. Actual critical stresses obtained from the tests were always found higher than the critical stresses obtained theoretically.

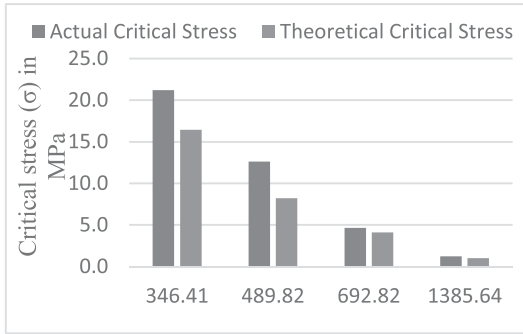

Fig. 34: $\frac{L_e}{r}$ Vs Critical Stress in MPa.

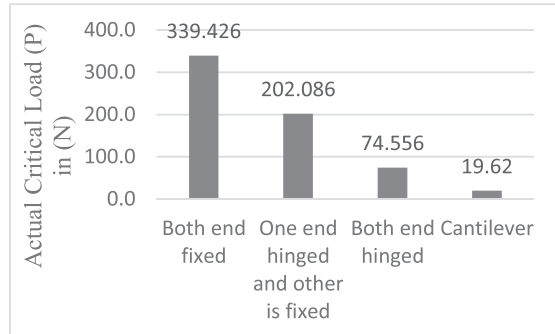

Fig. 35: Support Conditions Vs Critical Load (P) in (N)

Table 16: Actual and theoretical stress of 4 mm X 4 mm and 0.8 m length square column made with mild steel specimens.

End condition	Cross sectional size of the column in (mm)		X. sectional area (A) in (mm ²)	Radius of gyration (r)	Length of the column (L) in (mm)	Eff. Length (Le) in (mm)	Le/r in (mm)	Critical load in (N) (P)	Actual Critical stress in MPa P/A	Theo. critical stress in MPa
	Width	Thickness								
Both end fixed	4	4	16	1.1547	800	400	346.41	339.426	21.2141	16.449
One end hinged and other is fixed	4	4	16	1.1547	800	565.6	489.82	202.086	12.6304	8.227
Both end hinged	4	4	16	1.1547	800	800	692.82	74.556	4.65975	4.112
Cantilever	4	4	16	1.1547	800	1600	1385.6	19.62	1.2263	1.028

3.0 CONCLUSIONS

The main objective of the study was to evaluate the effect of end conditions on the load carrying capacity of slender column. To determine the critical load carrying capacity both theoretical and experimental investigation was performed. Based on the results obtained from the analytical and experimental investigation of the present study on slender column the following specific conclusions can be made.

- a. The experimental results show that the actual load carrying capacity of the slender columns were higher most of the time than the theoretical load carrying capacity.
- b. The difference between the actual and theoretical load carrying capacity of the slender column was always higher for both ends fixed, and one end fixed and other one hinged support conditions. Values of actual and theoretical critical load found quite similar for both ends hinged and cantilever support condition.
- c. The actual critical load found approximately 2 times of the theoretical critical load for both ends fixed, and one end fixed and other one hinged support conditions.
- d. Critical load carrying capacity of the slender column made of mild steel specimen was found two times or higher than the stainless-steel specimen.
- e. Results also show that the load carrying capacity of the column linearly increases with the cross-sectional area for the same column length and end condition.
- f. The critical load carrying capacity of both end fixed support condition found significantly higher than the cantilever support condition for the same length slender column.
- g. The difference between the actual and theoretical load carrying capacity of the slender column inversely varies with the cross-sectional area of the column.

4.0 ACKNOWLEDGEMENT

In the end, the authors would like to acknowledge to the Sonargaon University for supporting with their Lab facilities to conduct the research.

References

- [1] Ibrahim E., "High-Rise Buildings – Needs & Impacts," CIB World Build. Congr. 2017, 2007.
- [2] Desai P. R. and Satish C., "Effect of Slenderness Ratio on Euler Critical Load for Elastic Columns with ANSYS .," J. Eng. Res. Appl. www.ijera.com, vol. 8, no. May, pp. 40–43, 2018.
- [3] Avcar M., "Elastic Buckling of Steel Columns Under Axial Compression," Am. J. Civ. Eng., vol. 2, no. 3, p. 102, 2014.
- [4] Aristizábal J. D. and Ochoa, "Large deflection stability of slender beam-columns with semi-rigid connections: Elastica approach," J. Eng. Mech., 2004.
- [5] Coşkun S. B., "Analysis of Tilt-Buckling of Euler Columns With Varying Flexural Stiffness Using Homotopy Perturbation Method," Math. Model. Anal., vol. 15, no. 3, pp. 275–286, 2010.
- [6] Coskun S. B. and Öztürk B., "Elastic Stability Analysis of Euler Columns Using Analytical Approximate Techniques," in Advances in Computational Stability Analysis, vol.2, 2012, pp.115–132.
- [7] Akin J.E., "Finite Element Analysis Concepts: Via SolidWorks", Chapter: 12 Buckling Analysis. World Scientific, 2010, 2009.
- [8] Bhoi R. and Kalurkar L. G., "Study of Buckling Behaviour of Beam and Column Subjected To Axial Loading for Various Rolled I Sections," vol. 3, no. 11, pp. 17639–17645, 2014.
- [9] Marathias P., Visvikis E., and Mousouleas P., "13th World Conference on Earthquake Engineering Spread – Of – Plasticity Analysis of R / C Buildings , Subjected to Monotonic ‘ Seismic ’ Loading," Vol. 2003, No. 2229, 2004.
- [10] Arif M. and Kisa M., "Buckling of Slender Prismatic Columns with a Single Edge Crack," vol. 29, pp. 185–193, 2005.
- [11] Bažant Z. P. and Cedolin L., Stability of Structures. 2010.
- [12] Barbero E. J. and Tomblin J., "Buckling Testing of Composite Columns," Aiaa J., vol. 30, no. 11, pp. 2798–2800, 1992.
- [13] Barbero E. J. and Raftoyiannis I. G., "Euler buckling of puitruted composite columns," Compos. Structure., vol. 24, pp. 139–147, 1993.
- [14] Kristensen T., "Study of production tolerances' impact on capacities with regards to EN-1999," Universitetet i Stavanger, 2016.
- [15] Hibbeler R. C., "Mechanics of Materials", Tenth Edition, vol. 136, no. 1. New York: Hoboken, NJ: Pearson, 2015.
- [16] C. Analysis, "Column Analysis and Design." [Online]. Available at: https://academic.csuohio.edu/duffy_s/Overview_Column_Analysis.pdf.